

# EDGE

By Hammel

40200-E5-P1 / 8

## 40200-E5

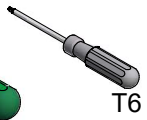
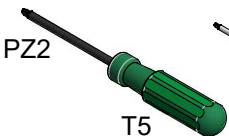
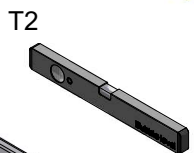
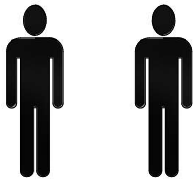
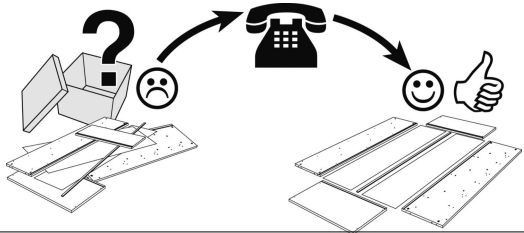
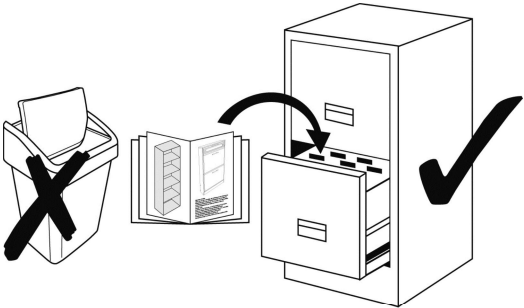

F1 x 2

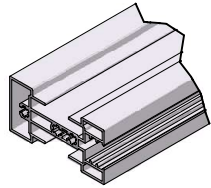

F2 x 2

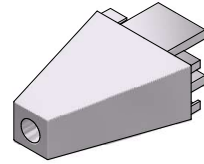

F3 x 2

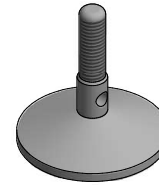

F4 x 4

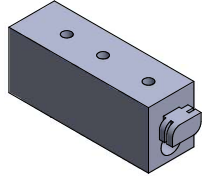

F5 x 2

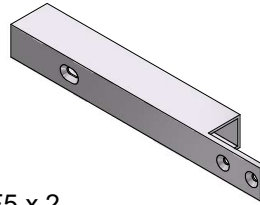

F6 x 8

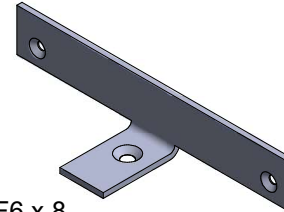

F7 x 2

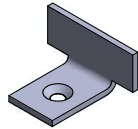

F8 x 10

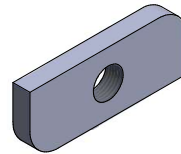

F9 x 10

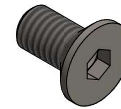

Ved ophængning af reol skal De selv sikre Dem væggenes beskaffenhed. Vort ansvar dækker kun den belastning, som selve reolen kan bære. Er De i tvivl kontakt da venligst en fagmand.

Before wall mounting of the modules, you have to make sure of the character of the wall. We are only responsible for the carrying capacity of the modules. In case of doubt, please contact an expert.

Vor Aufhängen der Elemente müssen Sie die Beschaffenheit der Wand sichern. Wir tragen nur die Verantwortung für die Belastungsfähigkeit der Elemente. Im Zweifelsfall, wenden Sie sich bitte an einen Fachmann.

En suspension de l'étagère, vous êtes responsable de la qualité du mur. Notre responsabilité ne comprend que le poids que l'étagère peut supporter. En cas de doute, veuillez consulter un expert.

Vid upphängning på väggen skall ni först och främst säkerställa väggens hållbarhet/skick. Vårt ansvar täcker endast modulens hållbarhet/viktbelastning enligt informationen. Är ni osäkra på väggens hållbarhet är det rekommenderat att ni kontaktar en fackman.

Ø4,2 x 25

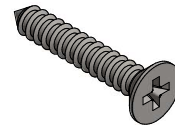

F10 x 8



F12 x 16



T4 x 1

Ø4,5 x 50

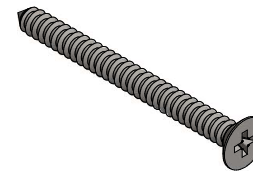

F11 x 2

F13 x 2

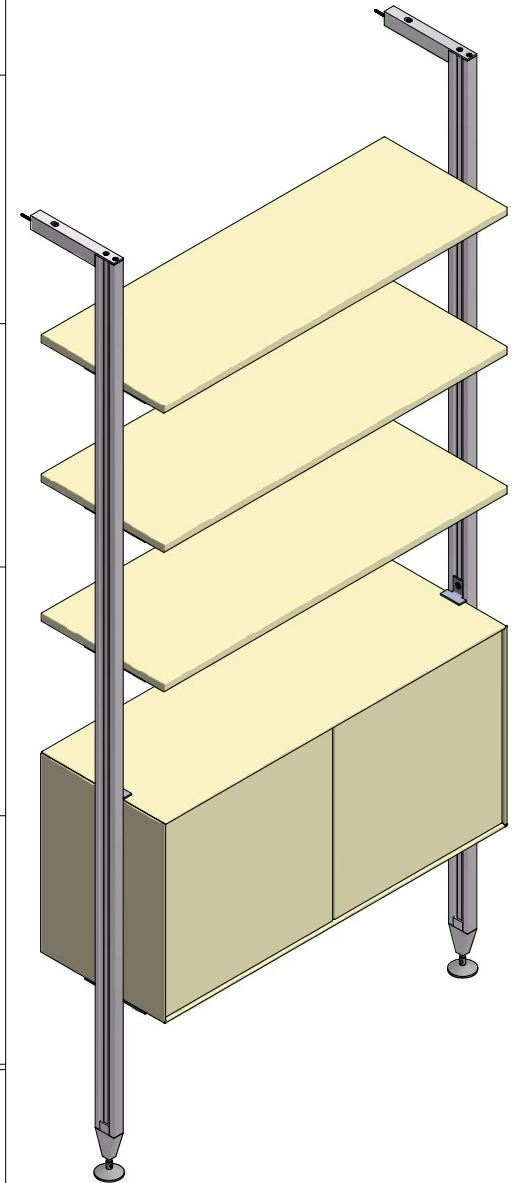
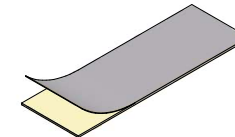

1

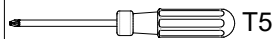
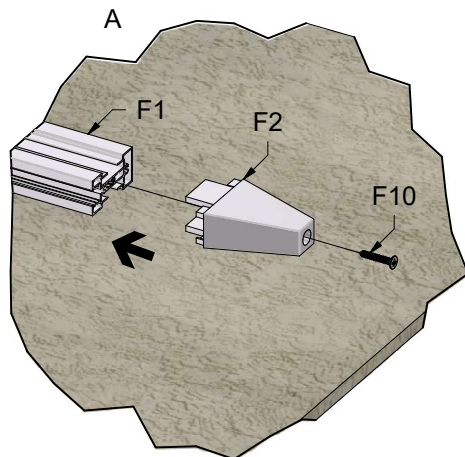
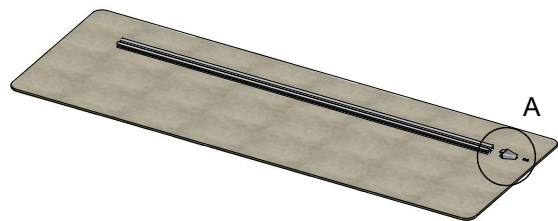

2

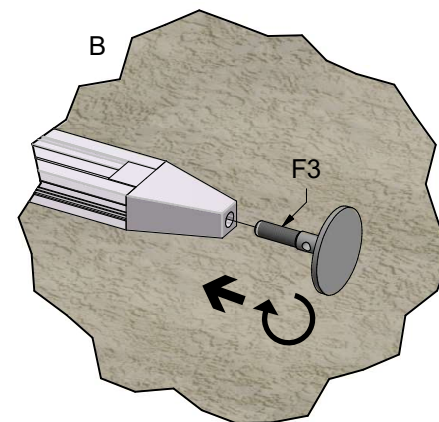
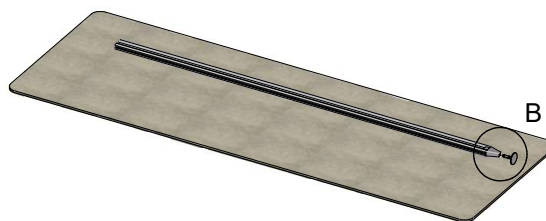

3

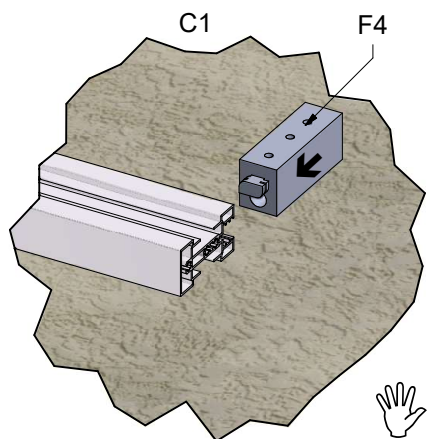
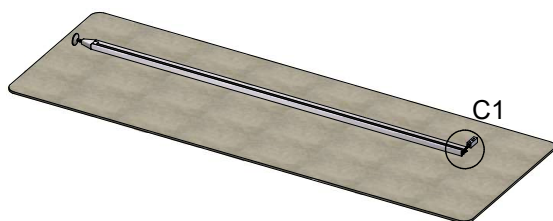

4

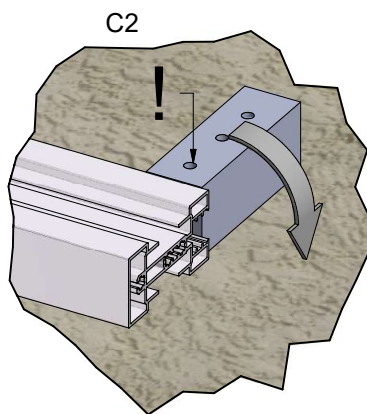
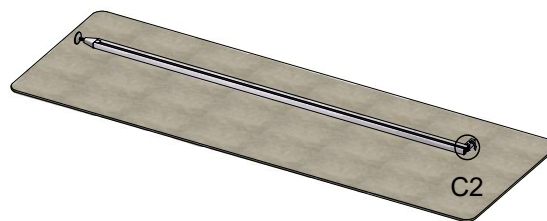

5

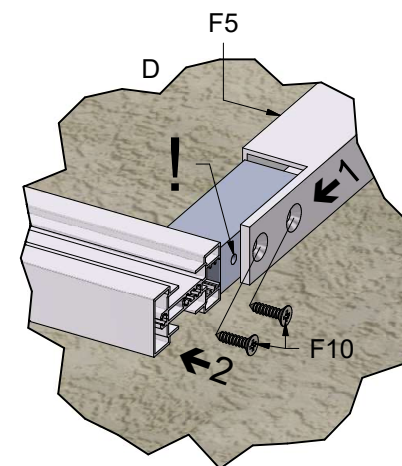
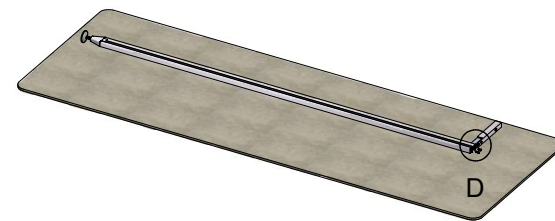

6



93,5 v 48,7 cm

208 cm

1 cm

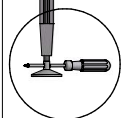

E

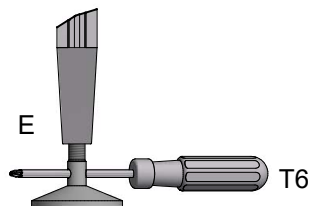

T6

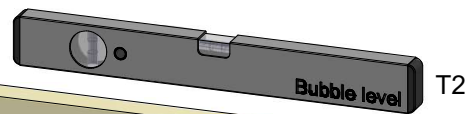

Bubble level T2

93,5 v 48,7 cm

T1

T1

208 cm



T3

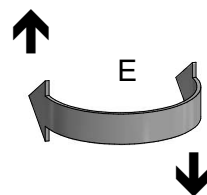

E

7

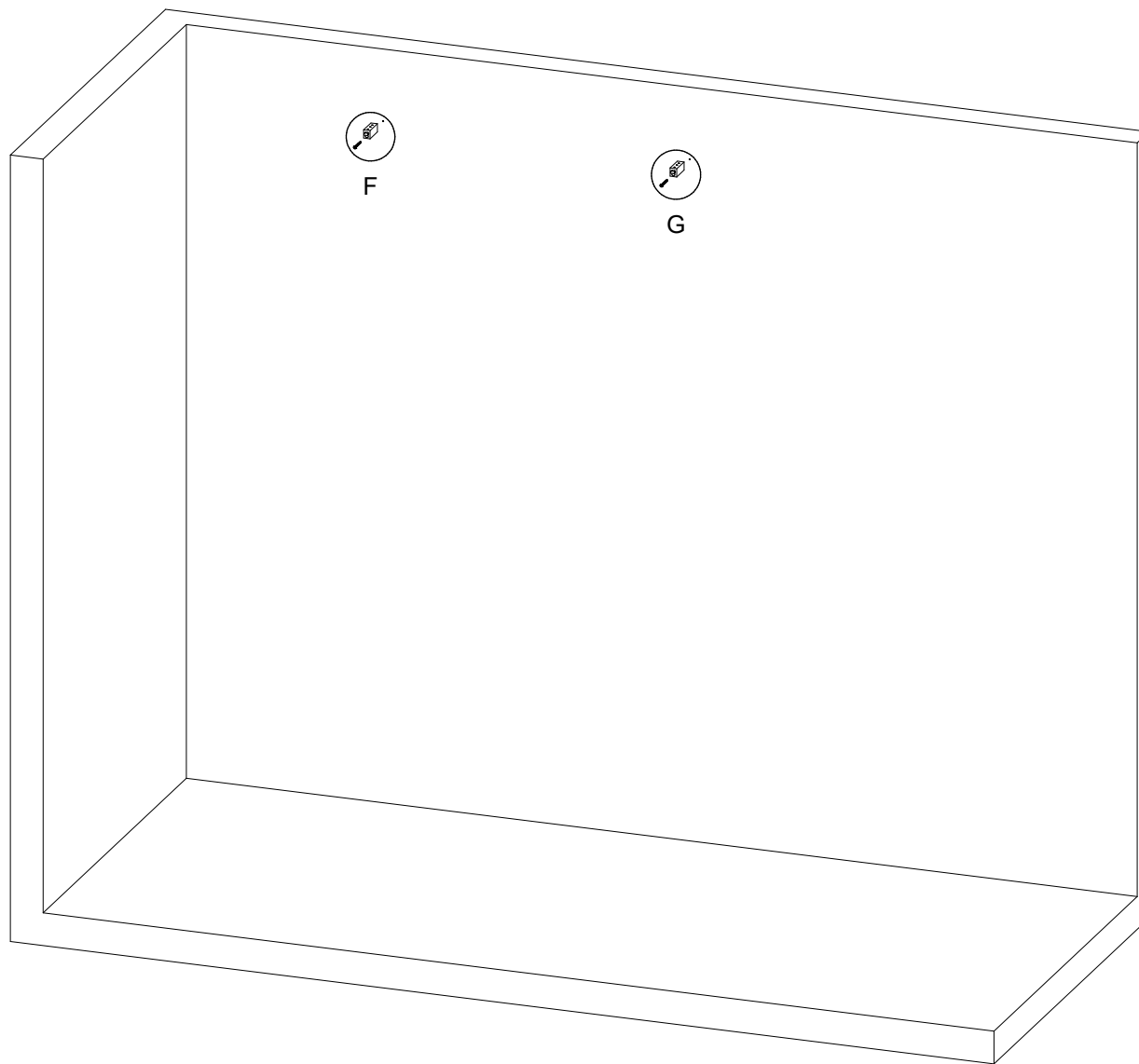
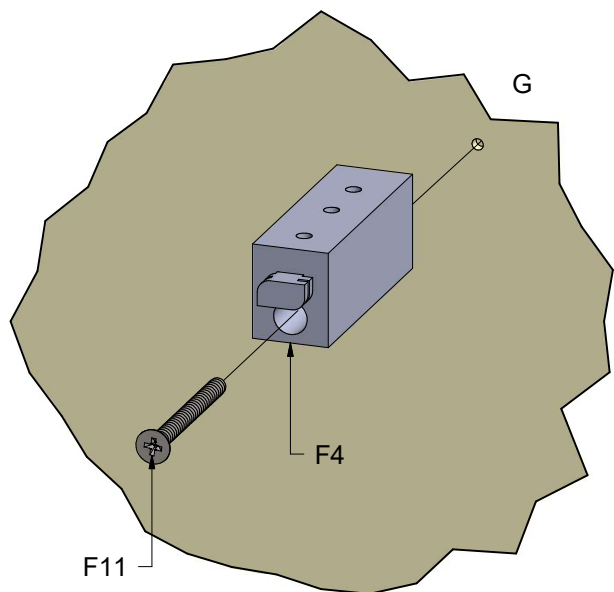
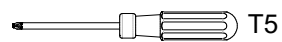
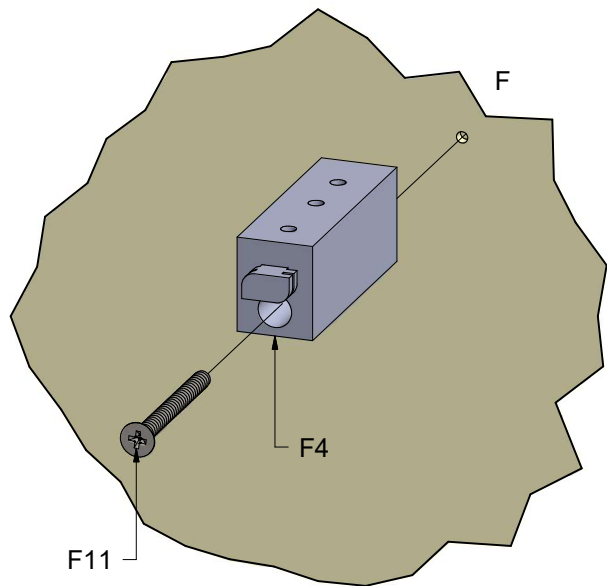

8

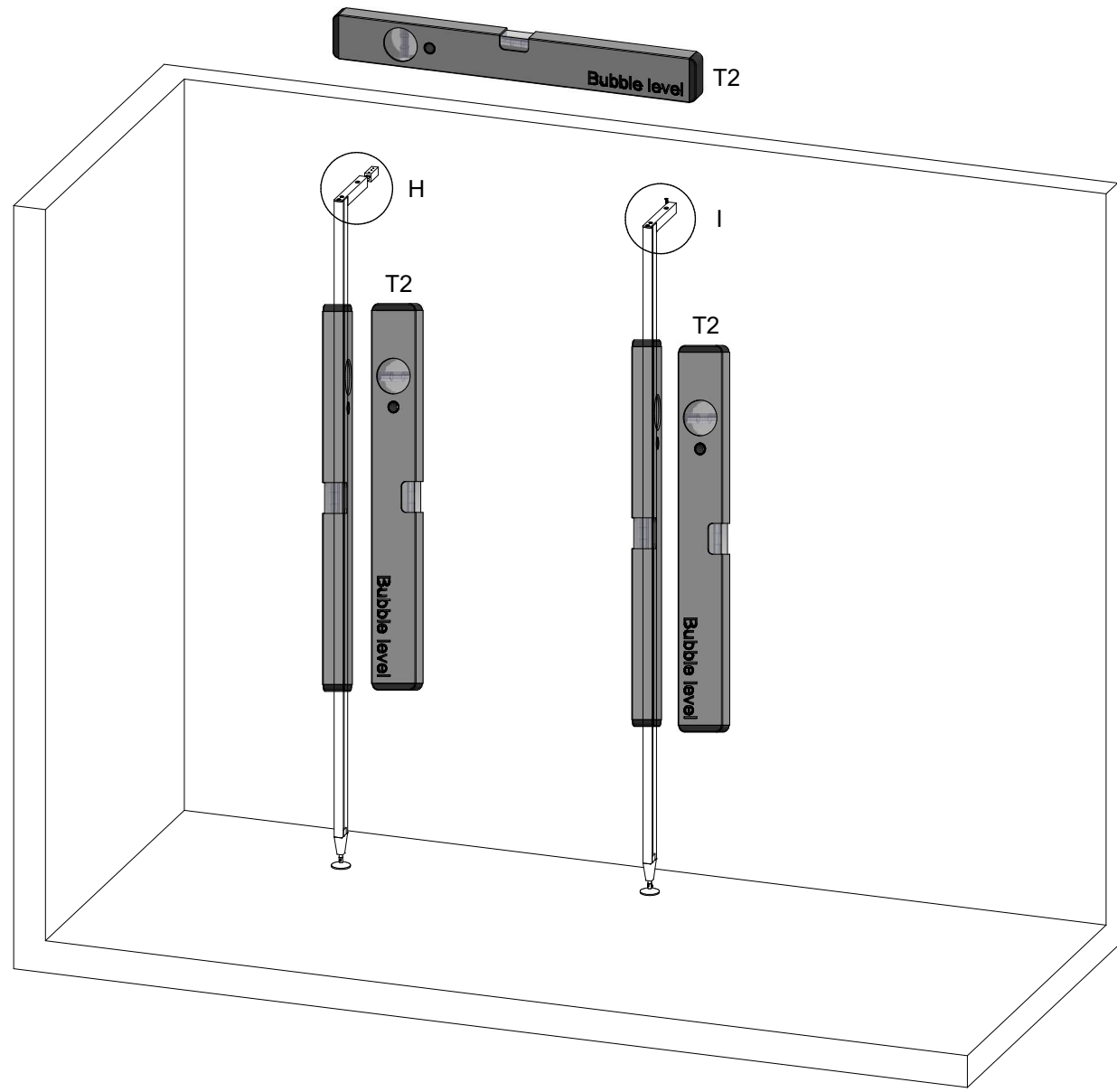
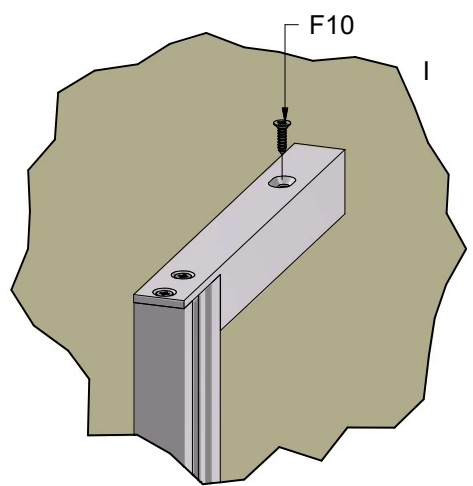
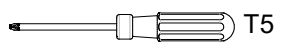
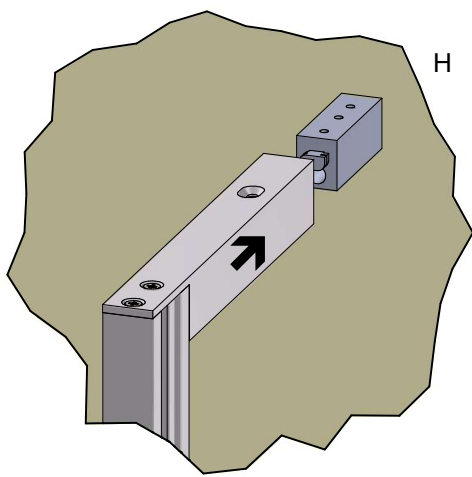

9

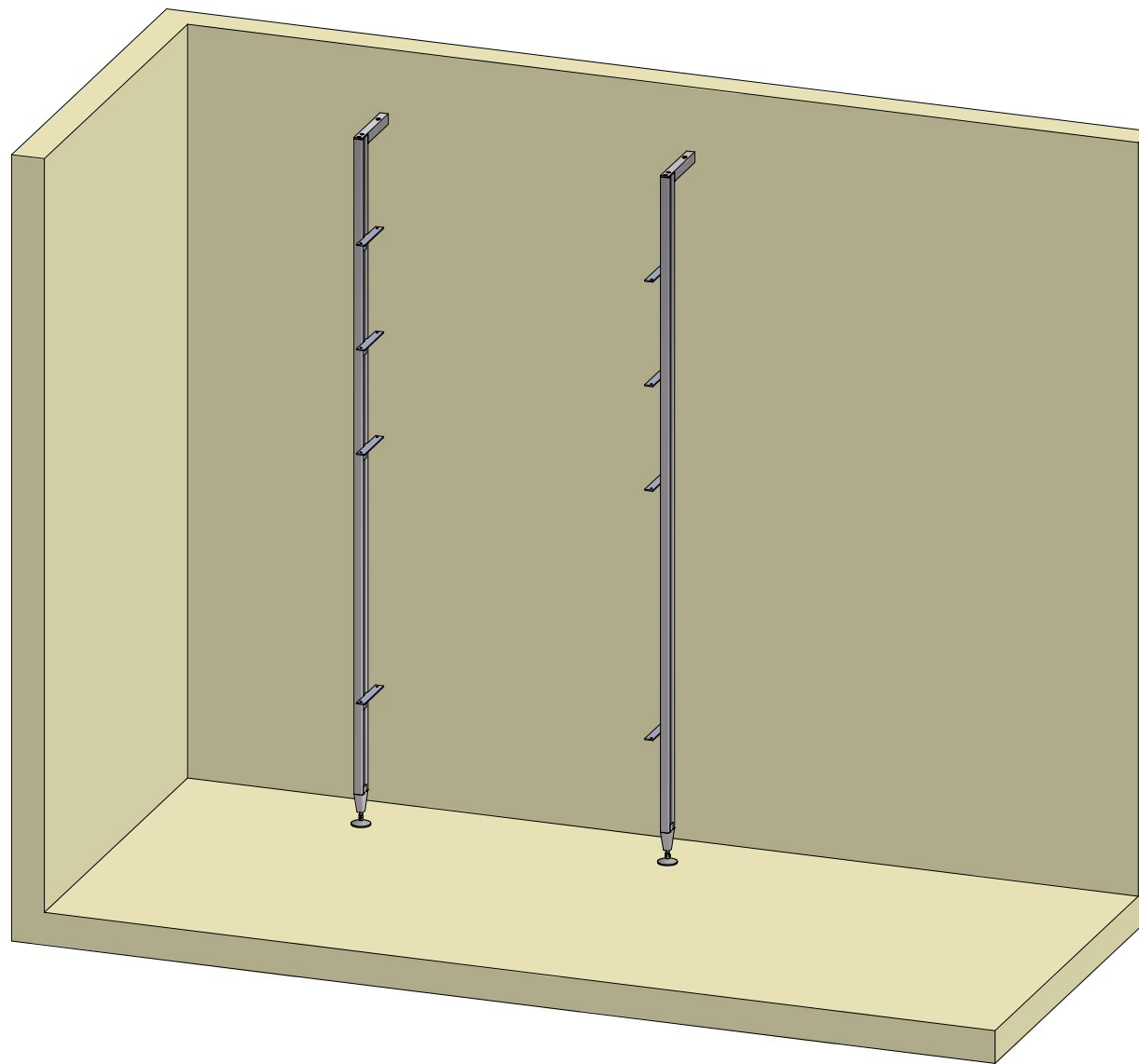
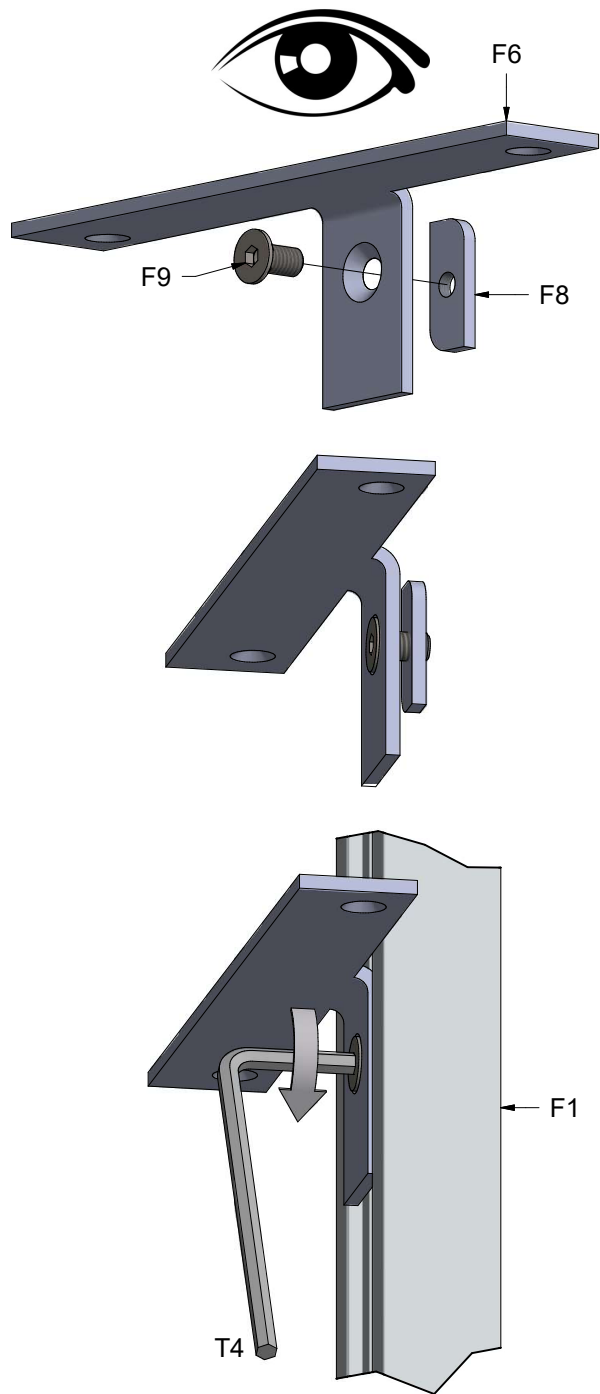

10

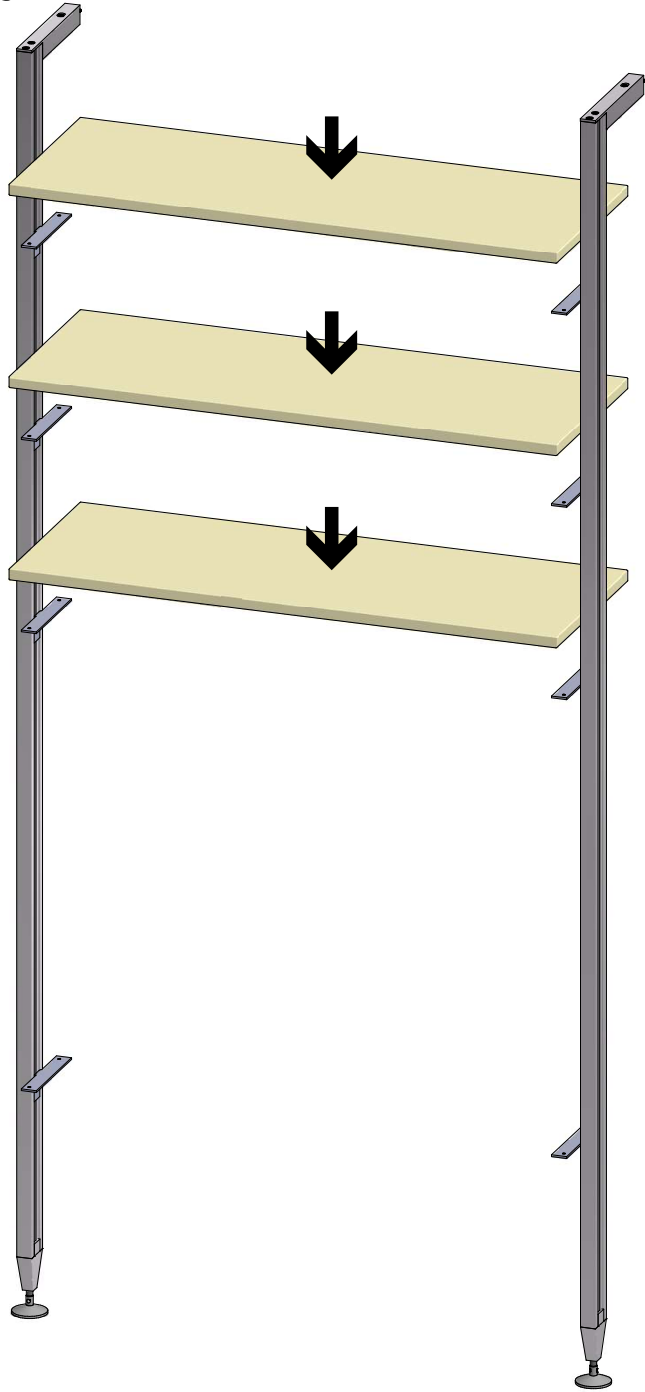

11

40200-E5-P7 /8

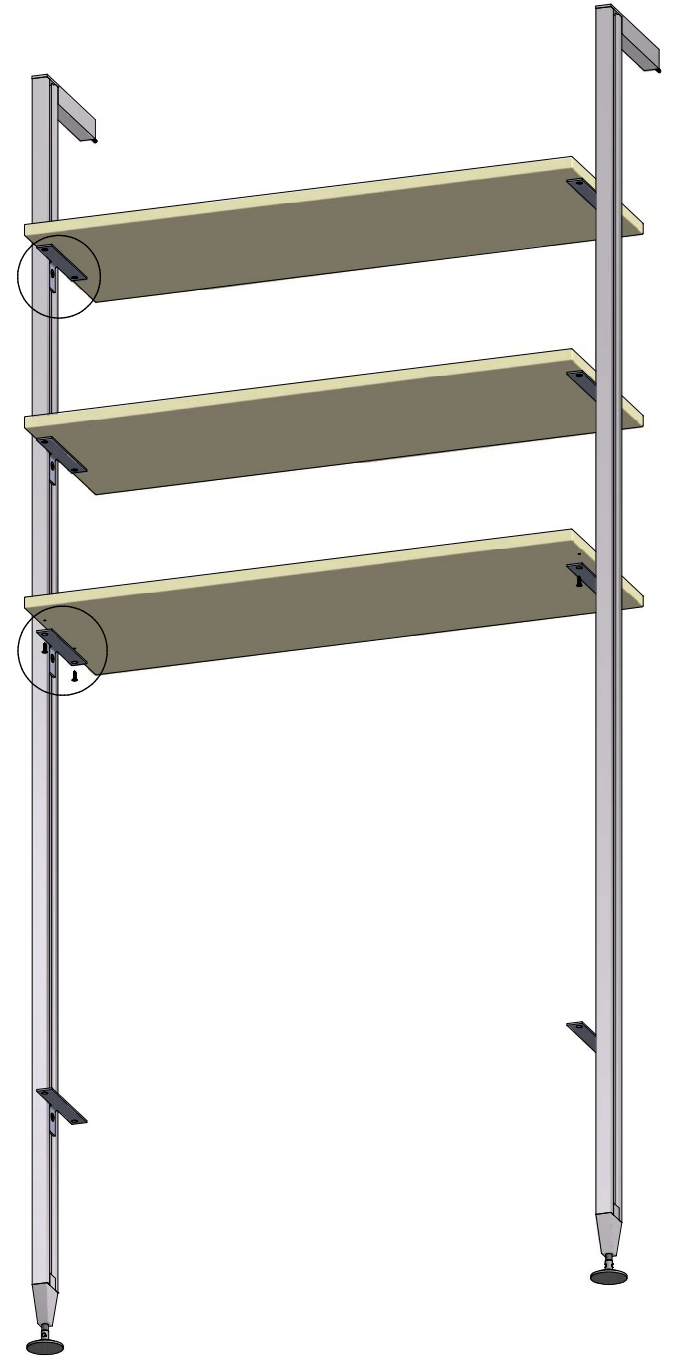
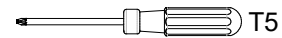
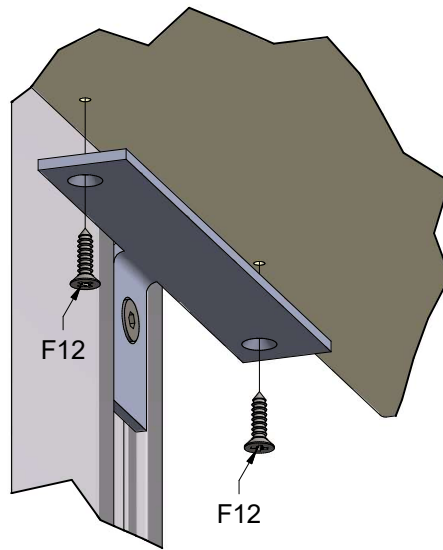
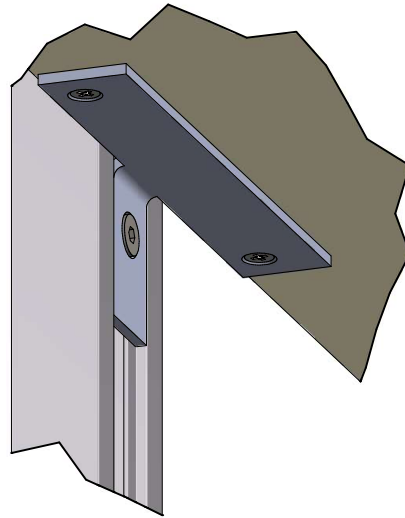



12

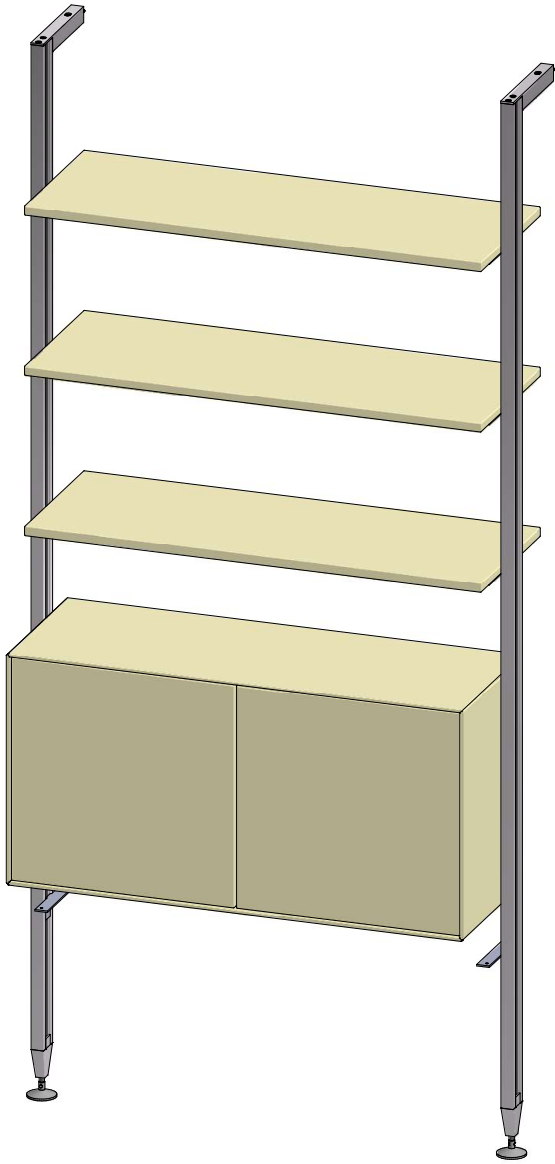

13

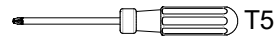
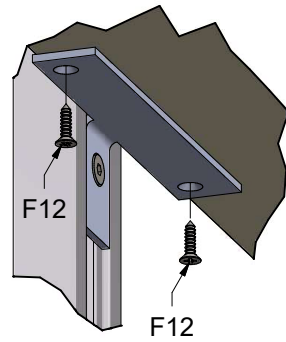
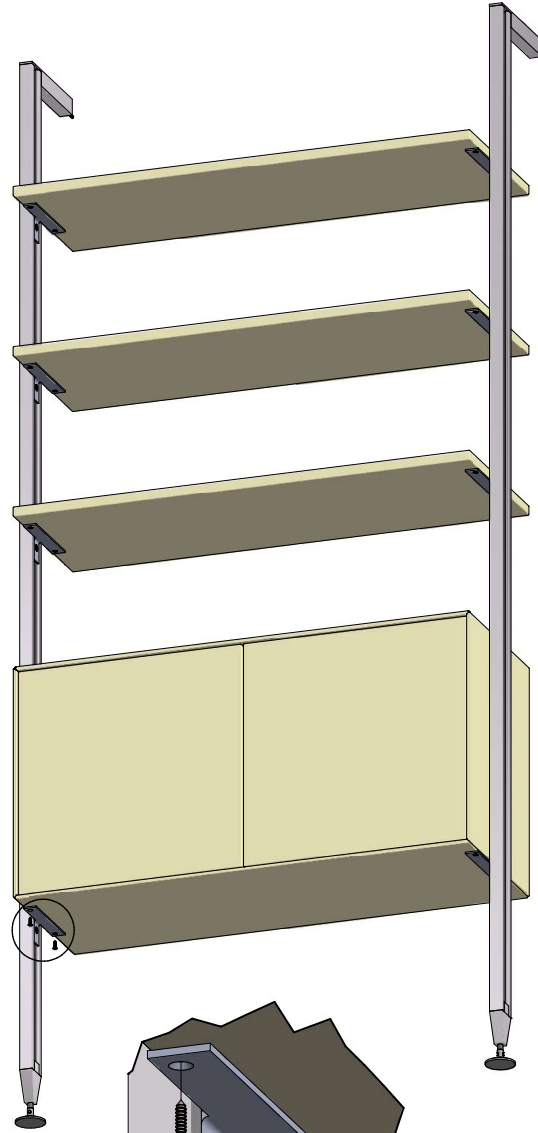

14

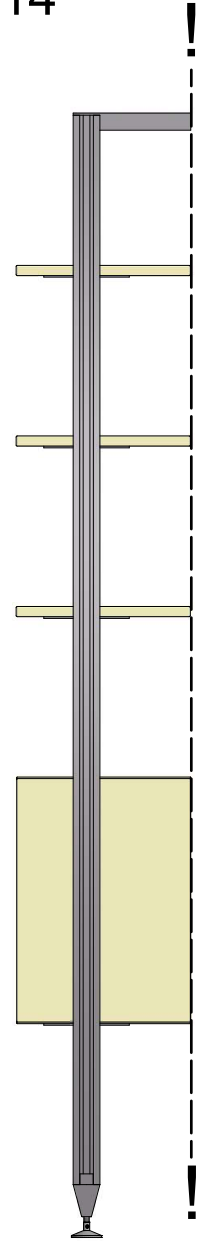

15

40200-E5-P8 /8

